

## AN-1135 LM267X 3A, 5A Evaluation Boards

### 1 Introduction

The LM267X evaluation board was developed for the evaluation of LM267X SIMPLE SWITCHER series of 3 Amp and 5 Amp high efficiency step-down (Buck) switching voltage regulators. This application note describes the printed circuit board, and provides example circuits and directions on setup and operation of the **LM2673S-5\_EVAL** and **LM2679S-5\_EVAL** evaluation boards.

### 2 General Description

Many of our boards are intended to provide the user with device characterization and layout optimization data. The LM267x evaluation board was intended to allow the user to experiment with a variety of circuit topologies and components, and therefore not optimized for size. Please refer to the discussions of layout optimization in the PCB Layout Optimization section.

This board was designed such that both through-hole and surface-mount components can be used for construction. The regulator IC can be placed on the board as a surface-mount component only. The ground plane serves as a heatsink.

[Table 1](#) shows an overview of the family of devices with special features of each indicated. Consult the device data sheet, or use the special power supply design software called **Switchers Made Simple version 6.X** (available for free download from [www.ti.com](http://www.ti.com)) to determine all necessary component values for the particular device being used to accomplish a specific design and board layout considerations.

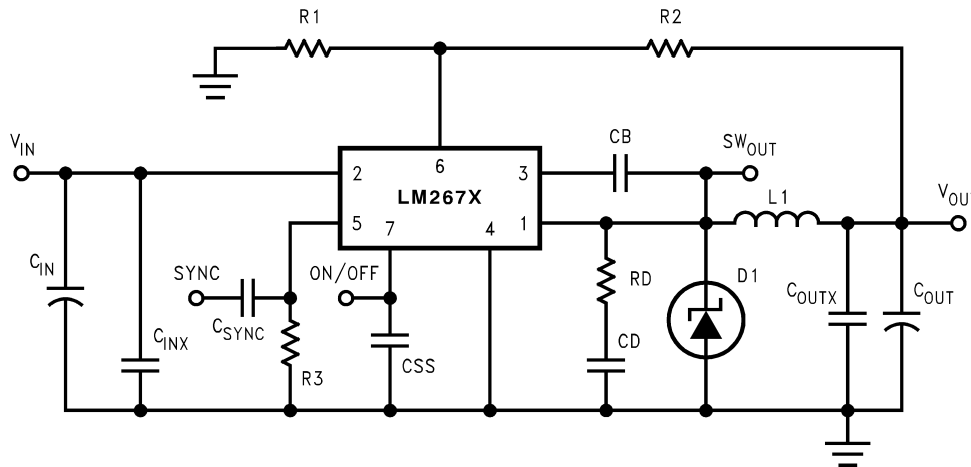
The printed circuit board, PCB, is labeled to indicate the location of all of the needed components for all possible design options. [Table 2](#) shows a complete list of the component labels and their functions.

[Figure 1](#) identifies all components, but not all are necessary in every design.

[Figure 2](#), [Figure 3](#) and [Figure 4](#) show the top, bottom and silk screen of the printed circuit board respectively.

**Table 1. LM267X Family of High-Current Regulators supported by the Evaluation Board**

Device	Maximum Load Current (A)	Special Features
LM2670	3	ON/OFF, External Frequency Sync Capability
LM2673	3	Adjustable Current Limit, Softstart
LM2676	3	ON/OFF
LM2677	5	ON/OFF, External Frequency Sync. Capability
LM2678	5	ON/OFF
LM2679	5	Adjustable Current Limit, Softstart


**Figure 1. Example Schematic Showing Connection for all Components.**
**Table 2. List of Component Labels and Functionality**

Label	Function
U1	LM267 Switching Regulator IC
CIN	Input Capacitor(s); All devices.
CINX	0.47 $\mu$ F, optional high frequency input bypass capacitor, recommended in all designs: All devices.
CB	Boost capacitor; All devices.
D1	Catch diode; All devices.
R1	Feedback resistor for adjustable output converters. This designator is left open (not connected) for fixed output converters.
R2	Feedback resistor (typ. 1 k $\Omega$ ) for adjustable output converters. This designator is left shorted (replaced by a jumper wire) for fixed output voltage converters.
R3*	Current limit resistor for LM2673, LM2679; Sync input resistor (1 k $\Omega$ ) for LM2670 and LM2677; Not inserted for LM2676 and LM2678.
L1	Inductor; All devices.
CSYNC	Sync input capacitor (100 pF); LM2670 and LM2677 only. Not inserted with other devices.
CSS	Soft start capacitor; LM2673 and LM2679 only. Not inserted with other devices.
COUTX	0.47 $\mu$ F, optional high frequency output bypass capacitor; All devices.
COUT	Output capacitor(s); All devices.

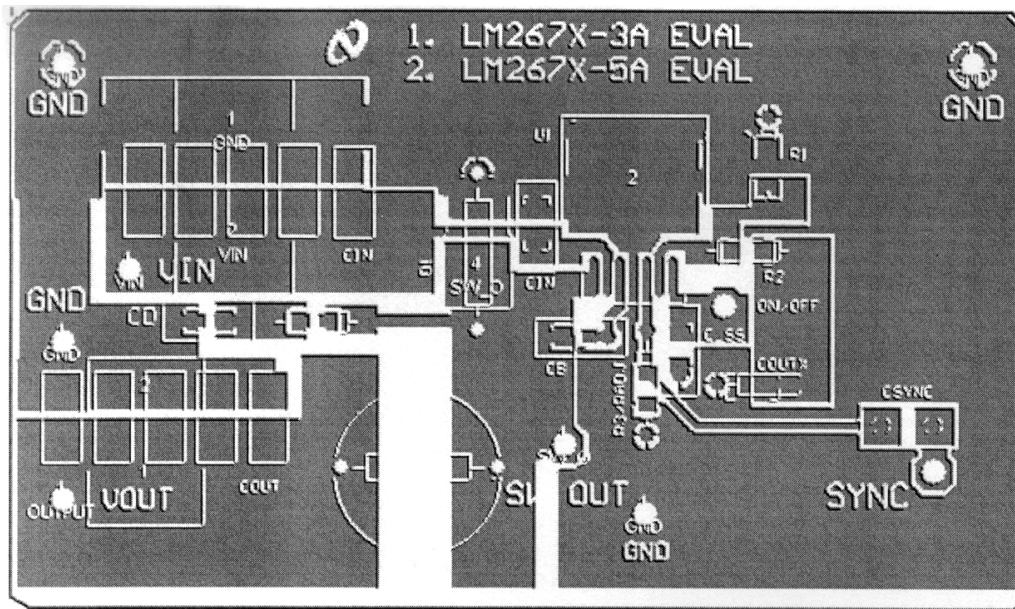


Figure 2. Top Layer Foil Pattern of Printed Circuit Board

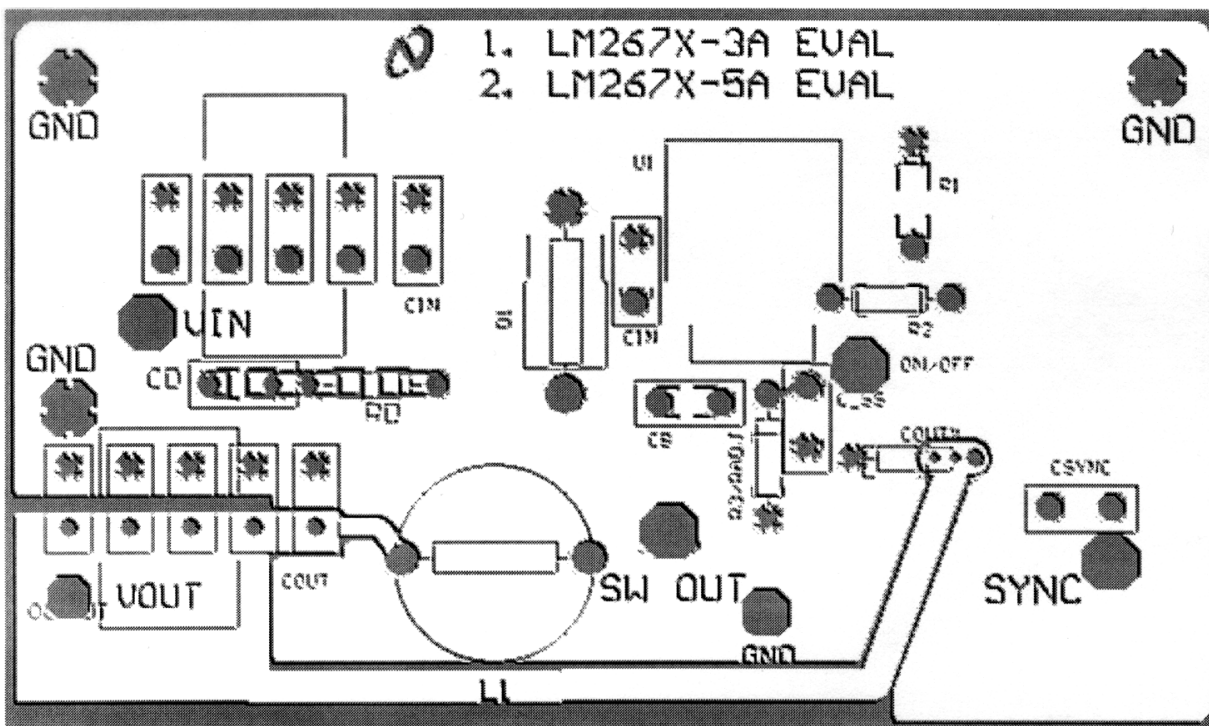
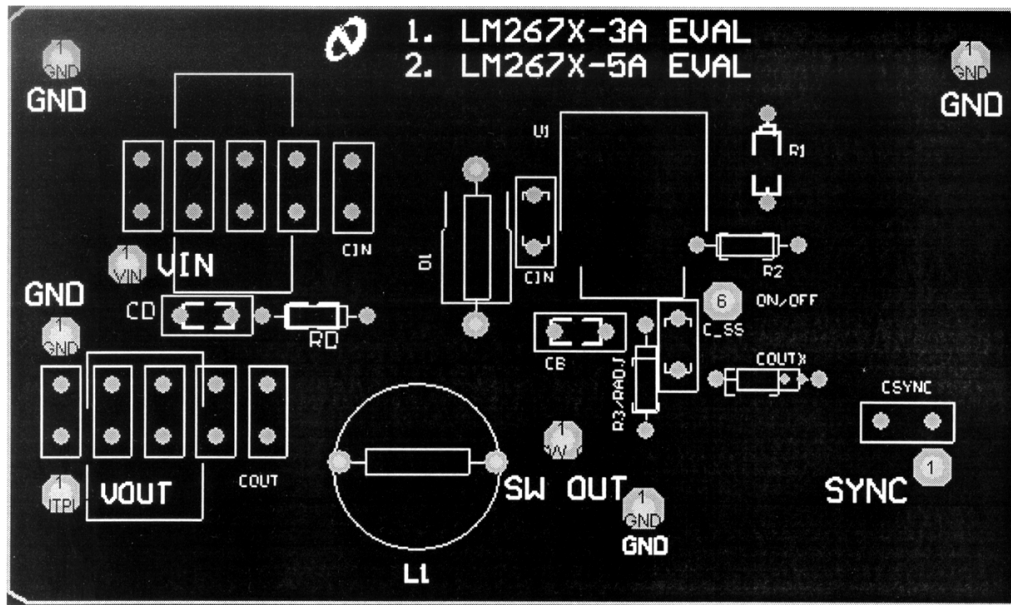


Figure 3. Bottom Layer Foil Pattern of Printed Circuit Board


**Figure 4. Silkscreen Image of Printed Circuit Board**

### 3 Special Notes

The evaluation board was designed primarily for circuit implementation using all surface-mount components. The small series "trace inductance", particularly from the Switch Output pin, can create a high frequency (10's of MHz) ringing signal at the switch output. If problematic, this ringing can be reduced or eliminated by the use of a series RC damper or snubber network from the switch output to ground. The addition of these components is made at the locations labeled CD and RD. Values of 0.01  $\mu\text{F}$  and 10 $\Omega$  are good starting values that may need to be varied depending on the magnitude of parasitic factors in a given design. In an actual end application, these components are normally not required if proper care to minimize trace lengths is taken in the PCB design.

### 4 Example Circuit Designs

#### **Example 1:** 5V/3A Converter with Surface Mount Components.

In this example, it is desired to convert a voltage range of between 8V and 12V, to 5VDC with load current of 3A. It is also desired to implement the design with surface mount components only. Softstart duration will be set to between 1 and 1.5 ms.

**Table 3. Target Design Specifications**

$V_{IN}$ min.	8V
$V_{IN}$ max.	16V
$V_{OUT}$	5V
$I_{LOAD}$	3A
$I_{CL}$	5.0A (approx.)
$T_{SS}$	1 to 1.5 ms

**Table 4. Component Values for an 8-12V in, 5V/3A Out LM2673S-5.0 Buck Converter**

Component	Value	Suggested Part Number
U1		Texas Instruments LM2673
CIN	2 x 33 $\mu\text{F}/35\text{V}$	Vishay 594D336X0035R2T
CINX	0.47 $\mu\text{F}$	Vishay VJ1210U474ZXAA

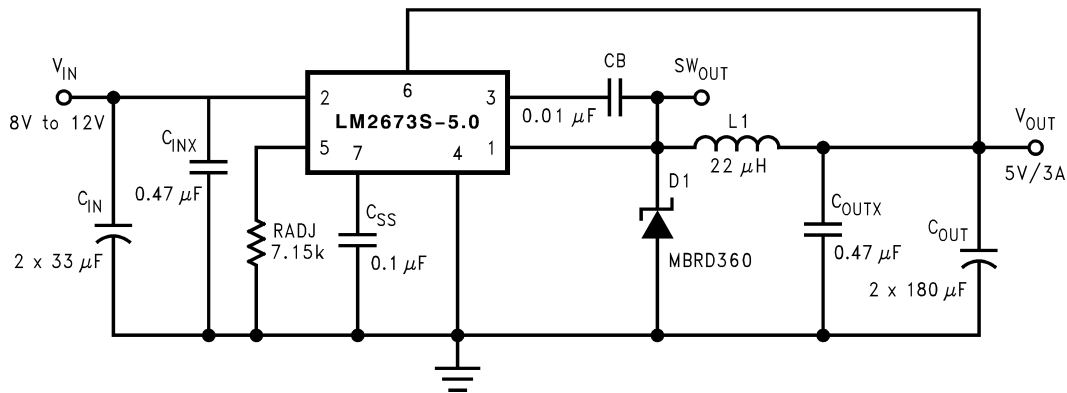


**Table 4. Component Values for an 8-12V in, 5V/3A Out LM2673S-5.0 Buck Converter (continued)**

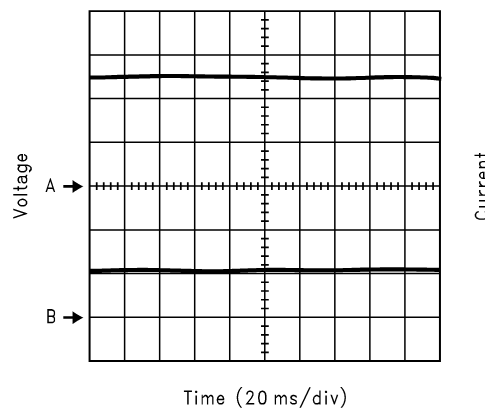
Component	Value	Suggested Part Number
CB	0.01 $\mu$ F/50V	Vishay VJ1206Y103MXXA
D1	3A/60V Schottky (450 mV at 3A)	Motorola MBRD360
R3*	7.15 k $\Omega$ (5.19A current limit)	Vishay CRCW12067151J
L1	22 $\mu$ H (L41)	SUMIDA ELECTRIC CO. CDRH127-220
CSS	3.3 nF/100V (softstart)	Vishay VJ1206Y33ZJXBAB
COUTX	0.47 $\mu$ F	Vishay VJ1210U474ZXAA
COUT	2 x 180 $\mu$ F/16V	Vishay 594D187X0016R2T

Figure 5 below shows the 5V/3A design circuit. This solution is available as evaluation board **LM2673S-5\_EVAL**.

Figure 6 through Figure 9 show the output waveforms for output voltage with 500 mA load, output voltage with 1A load, output ripple with 1A load, output voltage with 3A load, output ripple with 3A load, output response to 1A transient load and output response to 3A transient load respectively.

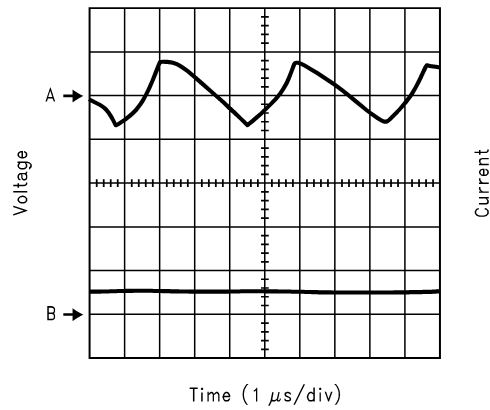


**Figure 5. 5V/3A Design Circuit**



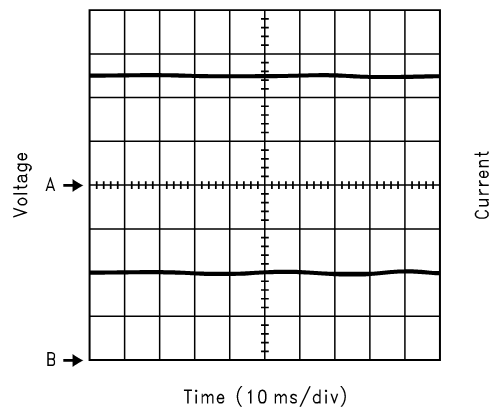
A: OUTPUT VOLTAGE:  $V_{OUT}$ ; 2V/DIV  
 B: LOAD CURRENT:  $I_{LOAD} = 500$  mA; 500 mA/DIV

**Figure 6. Output Voltage with 500 mA Load**



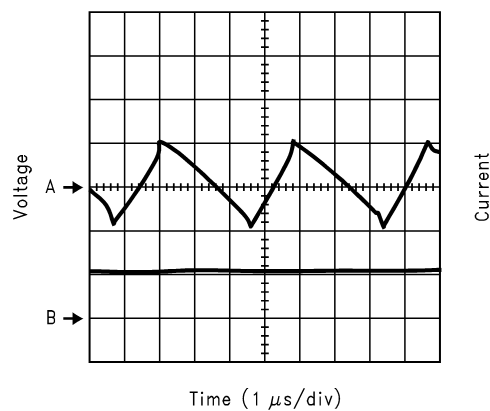
A: OUTPUT RIPPLE; 10 mV/DIV  
 B: LOAD CURRENT:  $I_{LOAD} = 0.5A$ ; 1A/DIV

**Figure 7. Output Ripple with 500 mA Load**



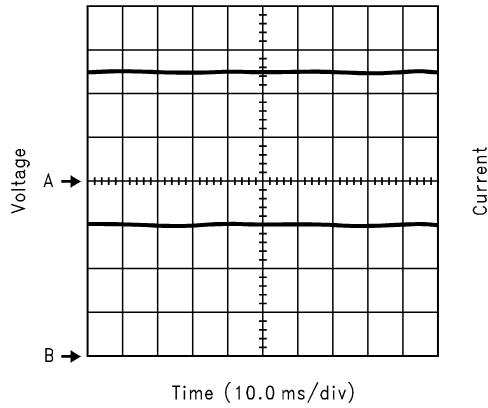
A: OUTPUT VOLTAGE:  $V_{OUT}$ ; 2V/DIV  
 B: LOAD CURRENT:  $I_{LOAD} = 1A$ ; 500 mA/DIV

**Figure 8. Output Voltage with 1A Load**



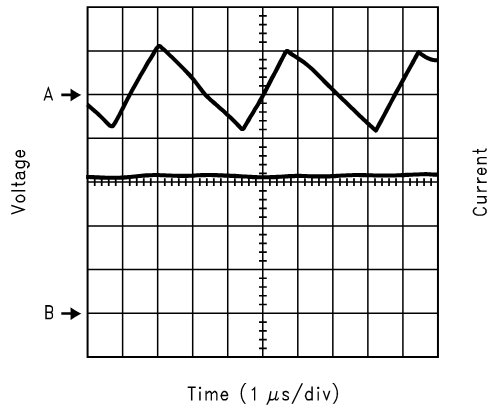
A: OUTPUT RIPPLE; 10 mV/DIV  
 B: LOAD CURRENT:  $I_{LOAD} = 1A$ ; 1A/DIV

**Figure 9. Output Ripple with 1 Amp Load**



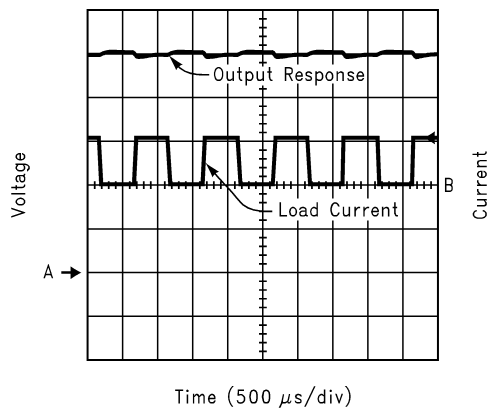
A: OUTPUT VOLTAGE:  $V_{OUT}$ ; 2V/DIV  
 B: LOAD CURRENT:  $I_{LOAD} = 3A$ ; 1A/DIV

**Figure 10. Output Voltage with 3A Load**



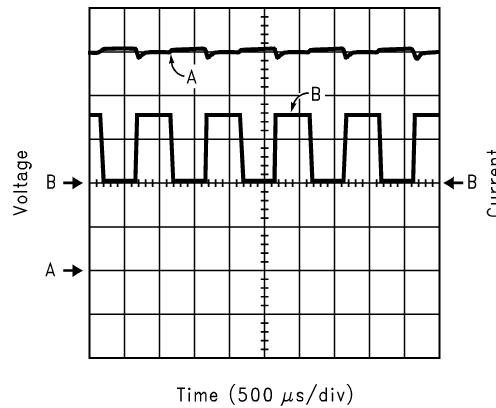
A: OUTPUT RIPPLE; 10 mV/DIV  
 B: LOAD CURRENT:  $I_{LOAD} = 3A$ ; 1A/DIV

**Figure 11. Output Ripple with 3 Amp Load**



A: OUTPUT RESPONSE; 1V/DIV  
 B: TRANSIENT LOAD CURRENT: 1A/DIV

**Figure 12. Output Response to 0~1A Transient Load**



A: OUTPUT RESPONSE; 1V/DIV  
 B: TRANSIENT LOAD CURRENT; 2A/DIV

**Figure 13. Output Response to 0~3A Load Transient**

### 5 Example 2: 5V/5A Design with Surface Mount Components

For this example, it is desired to design a power supply to convert an input voltage within the range of 14V and 28V to an output voltage of 5V with a maximum load current of 5A using only surface mount components. In addition, the current limit of the regulator will be set to approximately 7.0A, and the softstart time will be set to approximately 1.0 ms to limit the startup surge current.

**Table 5. Target Design Specifications:**

$V_{IN\ min.}$	14V
$V_{IN\ max.}$	28V
$V_{OUT}$	5V
$I_{LOAD}$	5A
$I_{CL}$	7.0A (approx.)
$T_{SS}$	1.0 ms (approx.)

**Table 6. Component Values for an 14V-28V in, 5V/5A Out LM2679S-5.0 Buck Converter**

Component	Value	Suggested Part Number
U1		Texas Instruments LM2679
CIN	3 x 15 $\mu$ F/50V	Vishay 594D156X0050R2T
CINX	0.47 $\mu$ F	Vishay VJ1210U474ZXAA
CB	0.01 $\mu$ F/50V	Vishay VJ1206Y103ZXXA
D1	8A/35V Schottky (500 mV at 5A)	Motorola MBRD835L
R3*	4.99 k $\Omega$ (7.19A current limit)	Vishay CRCW12064991J
L1	15 $\mu$ H	Coilcraft D05022P-153
CSS	4.7 nF/100V (1.0 ms softstart)	Vishay VJ1206Y47ZJXBAB
COUTX	0.47 $\mu$ F	Vishay VJ1210U474ZXAA
COUT	2 x 180 $\mu$ F/16V	Vishay 594D187X0016R2T

Figure 14 below shows the circuit for the 5V/5A design. This solution is available as evaluation board **LM2679S-5\_EVAL**.

Figure 14 through Figure 23 show the output waveforms for output voltage with 500 mA load, output voltage with 2.5A load, output ripple with 2.5A load, output voltage with 5A load, output ripple with 5A load, output response to 500 mA transient load, output response to 2.5A transient load and output response to 5A transient load respectively.



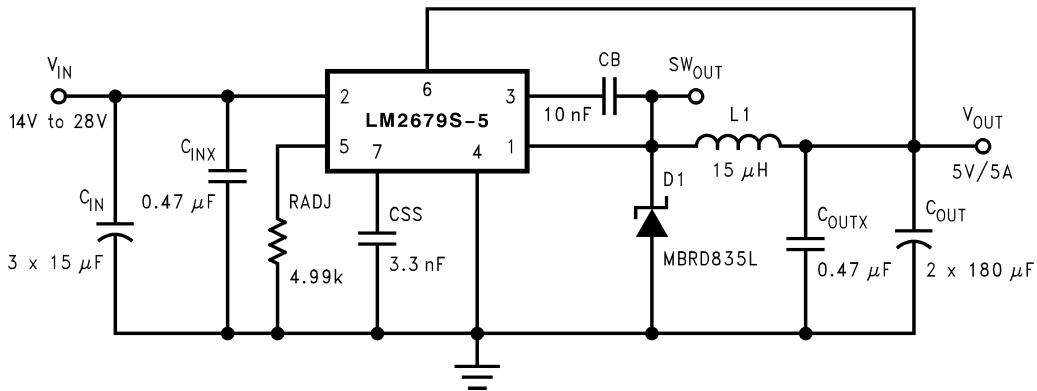
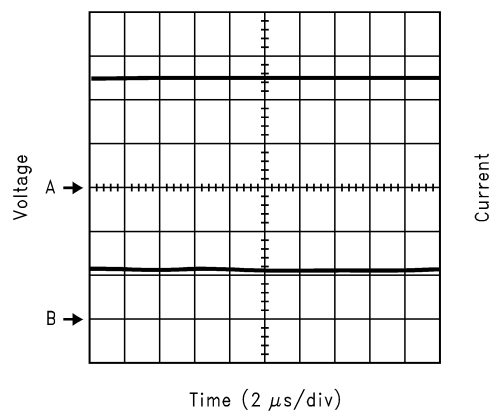
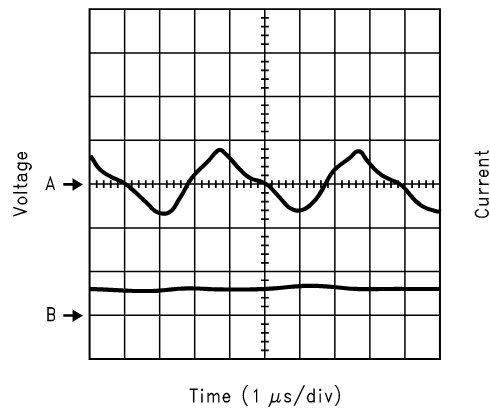


Figure 14. 5V/5A Design Circuit



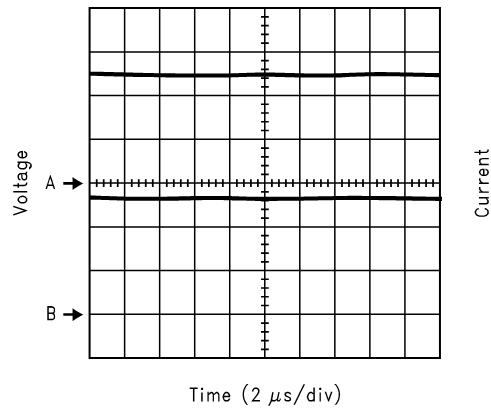
A: OUTPUT VOLTAGE:  $V_{OUT}$ ; 2V/DIV  
 B: LOAD CURRENT:  $I_{LOAD} = 500 \text{ mA}$ ; 500 mA/DIV

Figure 15. Output Voltage with 500 mA Load

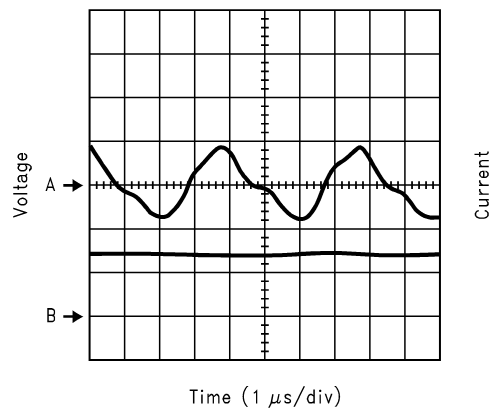


A: OUTPUT RIPPLE; 100 mV/DIV  
 B: LOAD CURRENT:  $I_{LOAD} = 500 \text{ mA}$ ; 1A/DIV

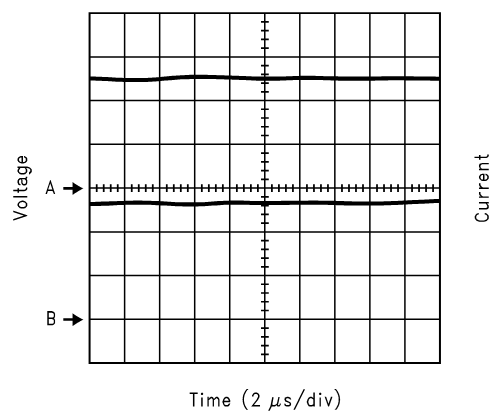
Figure 16. Output Ripple with 500 mA Load



A: OUTPUT VOLTAGE:  $V_{\text{OUT}}$ ; 2V/DIV  
 B: LOAD CURRENT:  $I_{\text{LOAD}} = 2.5\text{A}$ ; 1A/DIV

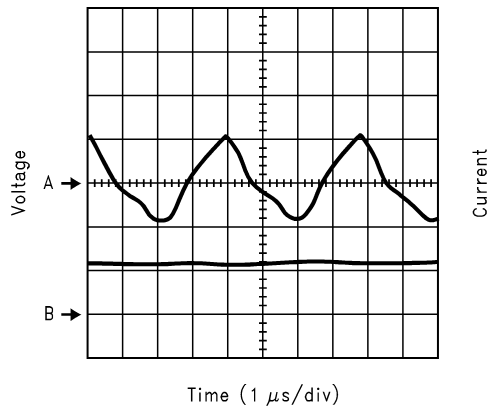
**Figure 17. Output Voltage with 2.5A Load**


A: OUTPUT RIPPLE; 100 mV/DIV  
 B: LOAD CURRENT:  $I_{\text{LOAD}} = 2.5\text{A}$ ; 2A/DIV

**Figure 18. Output Ripple with 2.5A Load**


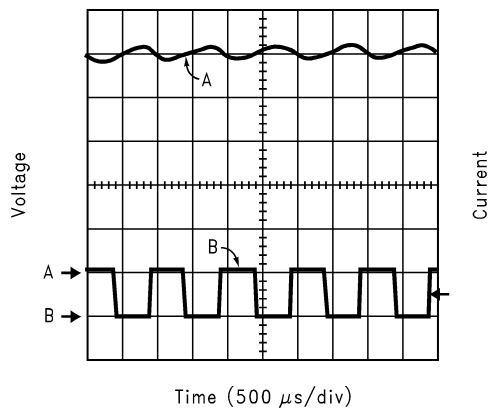
A: OUTPUT VOLTAGE:  $V_{\text{OUT}}$ ; 2V/DIV  
 B: LOAD CURRENT:  $I_{\text{LOAD}} = 5\text{A}$ ; 2A/DIV

**Figure 19. Output Voltage with 5A Load**



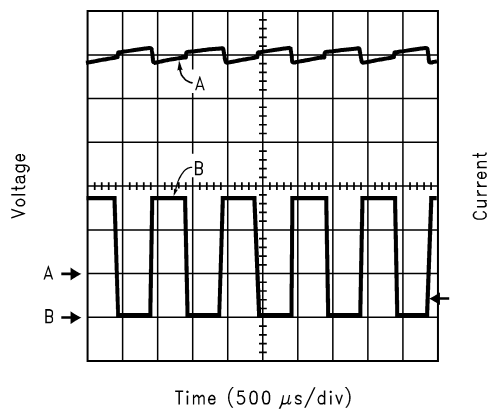
A: OUTPUT RIPPLE; 100 mV/DIV  
 B: LOAD CURRENT:  $I_{LOAD} = 5A$ ; 5A/DIV

**Figure 20. Output Ripple with 5A Load**



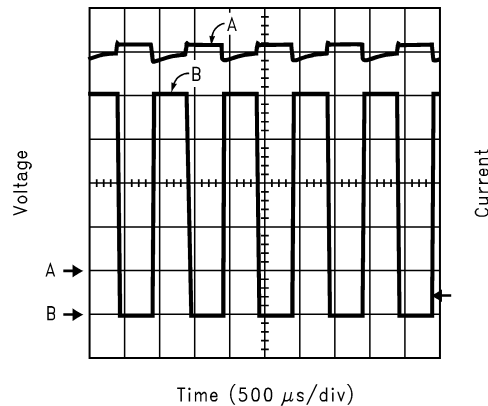
A: OUTPUT RESPONSE; 1V/DIV  
 B: TRANSIENT LOAD CURRENT: 500 mA/DIV

**Figure 21. Output Response to 0~0.5A Transient Load**



A: OUTPUT RESPONSE; 1V/DIV  
 B: TRANSIENT LOAD CURRENT: 1A/DIV

**Figure 22. Output Response to 0~2.5A Load Transient**



A: OUTPUT RESPONSE: 1V/DIV  
 B: LOAD CURRENT:  $I_{LOAD} = 1A/DIV$

**Figure 23. Output Response to 0~5A Transient Load**

## 6 Operating the Evaluation Boards

### 6.1 Setup

The **LM2673S-5\_EVAL** and **LM2679S-5\_EVAL** evaluation boards come ready to be tested. The only setup needed is connecting the input voltage to the VIN and GND posts. The output can be taken from the VOUT post. The other signals of interest, switch output (SW out) and softstart (C\_SS) posts, are clearly marked for use in checking the signal integrity. The softstart post has an ON/OFF input when this feature is being used.

### 6.2 Operating Conditions

The input source for the LM267x family of regulators must be 8V or greater for proper setup and operation. The input voltage range for **LM2673S-5\_EVAL** evaluation board is from 8V to 12V and the range for **LM2679S-5\_EVAL** is from 14V to 28V. The maximum voltage rating of the LM267x family of regulators is 40V.

Load can be applied from 0A to the maximum for the design. Higher current above the design current limit will result in activation of the design current limit circuit. It is advisable to have a minimal load of (at least 10 mA) during startup when the input to output differential voltage is greater than 10V to prevent output ramping beyond desired value.

### 6.3 PCB Layout Optimization

As in any switching regulator, layout is very important. Rapidly switching currents associated with wiring inductance can generate voltage transients which can cause problems. For minimal inductance and ground loops, the printed circuit traces should be as wide and short as possible on the PCB. For best results, external components should be located as close to the switcher IC as possible using ground plane construction or single point grounding.

If **open core inductors are used**, special care must be taken as to the location and positioning of this type of inductor. Allowing the inductor flux to intersect sensitive feedback, IC groundpath and  $C_{OUT}$  wiring can cause problems.

When using the adjustable version, special care must be taken as to the location of the feedback resistors and associated wiring. Physically locate both resistors near the IC, and route the wiring away from the inductor, especially an open core type of inductor.

## IMPORTANT NOTICE

Texas Instruments Incorporated and its subsidiaries (TI) reserve the right to make corrections, enhancements, improvements and other changes to its semiconductor products and services per JESD46, latest issue, and to discontinue any product or service per JESD48, latest issue. Buyers should obtain the latest relevant information before placing orders and should verify that such information is current and complete. All semiconductor products (also referred to herein as "components") are sold subject to TI's terms and conditions of sale supplied at the time of order acknowledgment.

TI warrants performance of its components to the specifications applicable at the time of sale, in accordance with the warranty in TI's terms and conditions of sale of semiconductor products. Testing and other quality control techniques are used to the extent TI deems necessary to support this warranty. Except where mandated by applicable law, testing of all parameters of each component is not necessarily performed.

TI assumes no liability for applications assistance or the design of Buyers' products. Buyers are responsible for their products and applications using TI components. To minimize the risks associated with Buyers' products and applications, Buyers should provide adequate design and operating safeguards.

TI does not warrant or represent that any license, either express or implied, is granted under any patent right, copyright, mask work right, or other intellectual property right relating to any combination, machine, or process in which TI components or services are used. Information published by TI regarding third-party products or services does not constitute a license to use such products or services or a warranty or endorsement thereof. Use of such information may require a license from a third party under the patents or other intellectual property of the third party, or a license from TI under the patents or other intellectual property of TI.

Reproduction of significant portions of TI information in TI data books or data sheets is permissible only if reproduction is without alteration and is accompanied by all associated warranties, conditions, limitations, and notices. TI is not responsible or liable for such altered documentation. Information of third parties may be subject to additional restrictions.

Resale of TI components or services with statements different from or beyond the parameters stated by TI for that component or service voids all express and any implied warranties for the associated TI component or service and is an unfair and deceptive business practice. TI is not responsible or liable for any such statements.

Buyer acknowledges and agrees that it is solely responsible for compliance with all legal, regulatory and safety-related requirements concerning its products, and any use of TI components in its applications, notwithstanding any applications-related information or support that may be provided by TI. Buyer represents and agrees that it has all the necessary expertise to create and implement safeguards which anticipate dangerous consequences of failures, monitor failures and their consequences, lessen the likelihood of failures that might cause harm and take appropriate remedial actions. Buyer will fully indemnify TI and its representatives against any damages arising out of the use of any TI components in safety-critical applications.

In some cases, TI components may be promoted specifically to facilitate safety-related applications. With such components, TI's goal is to help enable customers to design and create their own end-product solutions that meet applicable functional safety standards and requirements. Nonetheless, such components are subject to these terms.

No TI components are authorized for use in FDA Class III (or similar life-critical medical equipment) unless authorized officers of the parties have executed a special agreement specifically governing such use.

Only those TI components which TI has specifically designated as military grade or "enhanced plastic" are designed and intended for use in military/aerospace applications or environments. Buyer acknowledges and agrees that any military or aerospace use of TI components which have **not** been so designated is solely at the Buyer's risk, and that Buyer is solely responsible for compliance with all legal and regulatory requirements in connection with such use.

TI has specifically designated certain components as meeting ISO/TS16949 requirements, mainly for automotive use. In any case of use of non-designated products, TI will not be responsible for any failure to meet ISO/TS16949.

### Products

Audio	<a href="http://www.ti.com/audio">www.ti.com/audio</a>
Amplifiers	<a href="http://amplifier.ti.com">amplifier.ti.com</a>
Data Converters	<a href="http://dataconverter.ti.com">dataconverter.ti.com</a>
DLP® Products	<a href="http://www.dlp.com">www.dlp.com</a>
DSP	<a href="http://dsp.ti.com">dsp.ti.com</a>
Clocks and Timers	<a href="http://www.ti.com/clocks">www.ti.com/clocks</a>
Interface	<a href="http://interface.ti.com">interface.ti.com</a>
Logic	<a href="http://logic.ti.com">logic.ti.com</a>
Power Mgmt	<a href="http://power.ti.com">power.ti.com</a>
Microcontrollers	<a href="http://microcontroller.ti.com">microcontroller.ti.com</a>
RFID	<a href="http://www.ti-rfid.com">www.ti-rfid.com</a>
OMAP Applications Processors	<a href="http://www.ti.com/omap">www.ti.com/omap</a>
Wireless Connectivity	<a href="http://www.ti.com/wirelessconnectivity">www.ti.com/wirelessconnectivity</a>

### Applications

Automotive and Transportation	<a href="http://www.ti.com/automotive">www.ti.com/automotive</a>
Communications and Telecom	<a href="http://www.ti.com/communications">www.ti.com/communications</a>
Computers and Peripherals	<a href="http://www.ti.com/computers">www.ti.com/computers</a>
Consumer Electronics	<a href="http://www.ti.com/consumer-apps">www.ti.com/consumer-apps</a>
Energy and Lighting	<a href="http://www.ti.com/energy">www.ti.com/energy</a>
Industrial	<a href="http://www.ti.com/industrial">www.ti.com/industrial</a>
Medical	<a href="http://www.ti.com/medical">www.ti.com/medical</a>
Security	<a href="http://www.ti.com/security">www.ti.com/security</a>
Space, Avionics and Defense	<a href="http://www.ti.com/space-avionics-defense">www.ti.com/space-avionics-defense</a>
Video and Imaging	<a href="http://www.ti.com/video">www.ti.com/video</a>

### TI E2E Community

[e2e.ti.com](http://e2e.ti.com)